

Transient Voltage Suppression Diodes: P4KE Series

Axial Leaded Type 400 W



■ Features

1. Reliable low cost construction utilizing molded plastic technique
2. Both bi-directional and uni-directional devices are available
3. Fast response time
4. Excellent clamping capacity
5. 400 W peak pulse power capability with a 10/1000 μ s waveform, repetition rate (duty cycle): 0.01%

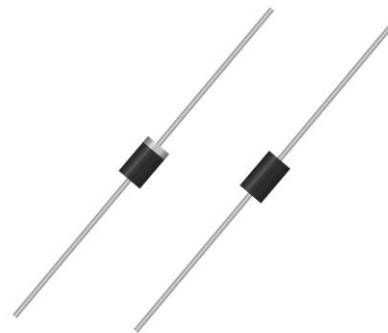

■ Recommended Applications

1. Telecommunication
2. Computer
3. Industrial device
4. Consumer electronic device

■ Mechanical Data

1. Package: DO-41 (DO-204AL)
2. Terminal: Matte Tin-plated leads, solderable per MIL-STD-750, Method 2026.
3. Polarity: The band denotes cathode (Note: no polarity indicator for bi-directional devices)

■ Part Number Code

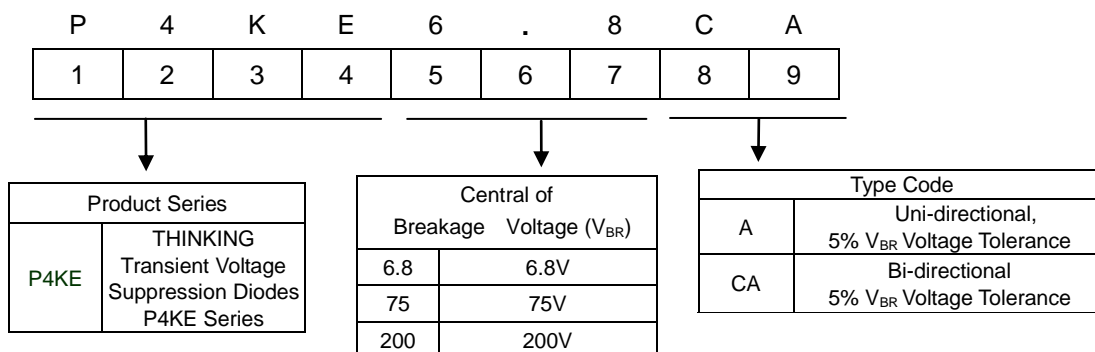

Transient Voltage Suppression Diodes: P4KE Series

Axial Leaded Type 400 W



■ Structures and Dimensions

DO-41 (DO-204AL)

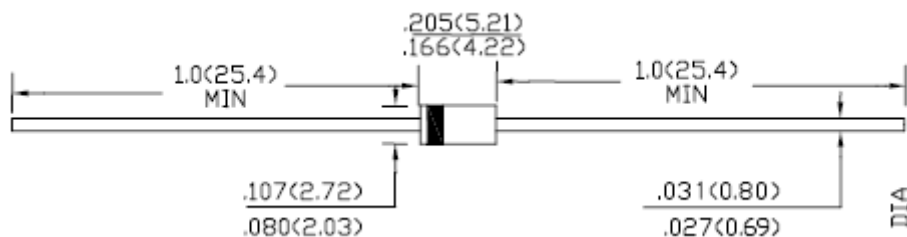

Unit: inch(millimeter)

■ Maximum Rating ($T_A=25^{\circ}\text{C}$ unless otherwise noted)

Parameter	Symbol	Value	Unit
Peak pulse power dissipation at $T_A=25^{\circ}\text{C}$ by 10/1000 μs waveform.	P_{PPM}	400	W
Peak Pulse Current of on 10/1000 μs waveform.	I_{PPM}	See Table	A
Peak forward surge current, 8.3ms single half sine wave on rated load.	I_{FSM}	40	A
Steady State Power Dissipation at $T_L=75^{\circ}\text{C}$.	P_D	1.5	W
Operating junction and storage temperature range.	T_J, T_{STG}	-55~+150	$^{\circ}\text{C}$

Transient Voltage Suppression Diodes: P4KE Series

Axial Leaded Type 400 W



■ Electrical Characteristics (T_A=25°C unless otherwise noted)

Part No. (Uni)	Part No. (Bi)	Reverse Stand off Voltage	Breakage Voltage V _{BR} @ I _T		Test Current	Maximum Clamping Voltage V _C @ I _{pp}	Maximum Peak Pulse Current	Maximum Reverse Leakage I _R @ VRWM
		V _{RWM} (V)	Min(V)	Max(V)	I _T (mA)	V _C (V)	I _{pp} (A)	I _R (μA)
P4KE6.8A	P4KE6.8CA	5.8	6.5	7.1	10	10.5	38.1	1000
P4KE7.5A	P4KE7.5CA	6.4	7.1	7.9	10	11.3	35.4	500
P4KE8.2A	P4KE8.2CA	7.0	7.8	8.6	10	12.1	33.1	200
P4KE9.1A	P4KE9.1CA	7.8	8.7	9.6	1	13.4	29.9	50
P4KE10A	P4KE10CA	8.6	9.5	10.5	1	14.5	27.6	10
P4KE11A	P4KE11CA	9.4	10.5	11.6	1	15.6	25.6	5
P4KE12A	P4KE12CA	10.2	11.4	12.6	1	16.7	24.0	5
P4KE13A	P4KE13CA	11.1	12.4	13.7	1	18.2	22.0	5
P4KE15A	P4KE15CA	12.8	14.3	15.8	1	21.2	18.9	5
P4KE16A	P4KE16CA	13.6	15.2	16.8	1	22.5	17.8	5
P4KE18A	P4KE18CA	15.3	17.1	18.9	1	25.2	15.9	5
P4KE20A	P4KE20CA	17.1	19.0	21.0	1	27.7	14.4	5
P4KE22A	P4KE22CA	18.8	20.9	23.1	1	30.6	13.1	5
P4KE24A	P4KE24CA	20.5	22.8	25.2	1	33.2	12.0	5
P4KE27A	P4KE27CA	23.1	25.7	28.4	1	37.5	10.7	5
P4KE30A	P4KE30CA	25.6	28.5	31.5	1	41.4	9.7	5
P4KE33A	P4KE33CA	28.2	31.4	34.7	1	45.7	8.8	5
P4KE36A	P4KE36CA	30.8	34.2	37.8	1	49.9	8.0	5
P4KE39A	P4KE39CA	33.3	37.1	41.0	1	53.9	7.4	5
P4KE43A	P4KE43CA	36.8	40.9	45.2	1	59.3	6.7	5
P4KE47A	P4KE47CA	40.2	44.7	49.4	1	64.8	6.2	5
P4KE51A	P4KE51CA	43.6	48.5	53.6	1	70.1	5.7	5
P4KE56A	P4KE56CA	47.8	53.2	58.8	1	77.0	5.2	5
P4KE62A	P4KE62CA	53.0	58.9	65.1	1	85.0	4.7	5
P4KE68A	P4KE68CA	58.1	64.6	71.4	1	92.0	4.3	5
P4KE75A	P4KE75CA	64.1	71.3	78.8	1	103.0	3.9	5
P4KE82A	P4KE82CA	70.1	77.9	86.1	1	113.0	3.5	5
P4KE91A	P4KE91CA	77.8	86.5	95.5	1	125.0	3.2	5
P4KE100A	P4KE100CA	85.5	95.0	105.0	1	137.0	2.9	5

Transient Voltage Suppression Diodes: P4KE Series

Axial Leaded Type 400 W



■ Electrical Characteristics ($T_A=25^{\circ}\text{C}$ unless otherwise noted)

Part No. (Uni)	Part No. (Bi)	Reverse Stand off Voltage	Breakage Voltage V_{BR} @ I_T		Test Current	Maximum Clamping Voltage V_C @ I_{pp}	Maximum Peak Pulse Current	Maximum Reverse Leakage I_R @ V_{RWM}
		V_{RWM} (V)	Min(V)	Max(V)	I_T (mA)	V_C (V)	I_{pp} (A)	I_R (μ A)
P4KE110A	P4KE110CA	94.0	105.0	116.0	1	152.0	2.6	5
P4KE120A	P4KE120CA	102.0	114.0	126.0	1	165.0	2.4	5
P4KE130A	P4KE130CA	111.0	124.0	137.0	1	179.0	2.3	5
P4KE150A	P4KE150CA	128.0	143.0	158.0	1	207.0	1.9	5
P4KE160A	P4KE160CA	136.0	152.0	168.0	1	219.0	1.8	5
P4KE170A	P4KE170CA	145.0	161.5	179.0	1	234.0	1.7	5
P4KE180A	P4KE180CA	154.0	171.0	189.0	1	246.0	1.6	5
P4KE200A	P4KE200CA	171.0	190.0	210.0	1	274.0	1.5	5
P4KE220A	P4KE220CA	185.0	209.0	231.0	1	328.0	1.2	5
P4KE250A	P4KE250CA	214.0	237.0	263.0	1	344.0	1.2	5
P4KE300A	P4KE300CA	256.0	285.0	315.0	1	414.0	1.0	5
P4KE350A	P4KE350CA	300.0	333.0	368.0	1	482.0	0.83	5
P4KE400A	P4KE400CA	342.0	380.0	420.0	1	548.0	0.73	5
P4KE440A	P4KE440CA	376.0	418.0	462.0	1	602.0	0.66	5

Transient Voltage Suppression Diodes: P4KE Series

Axial Leaded Type 400 W



Rate and Characteristic Curve ($T_A=25^\circ\text{C}$ unless otherwise noted)

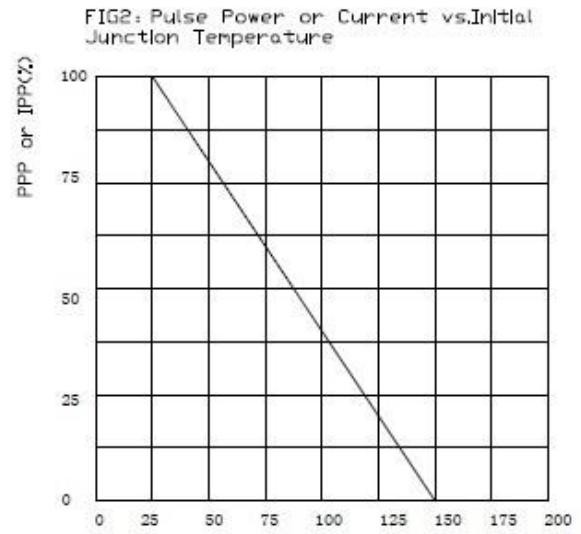
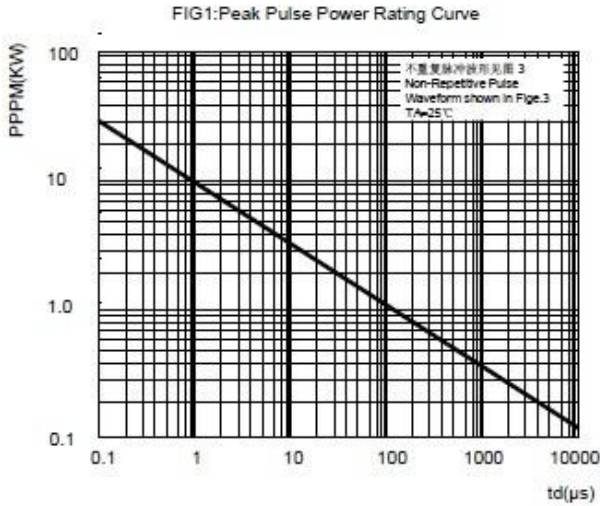
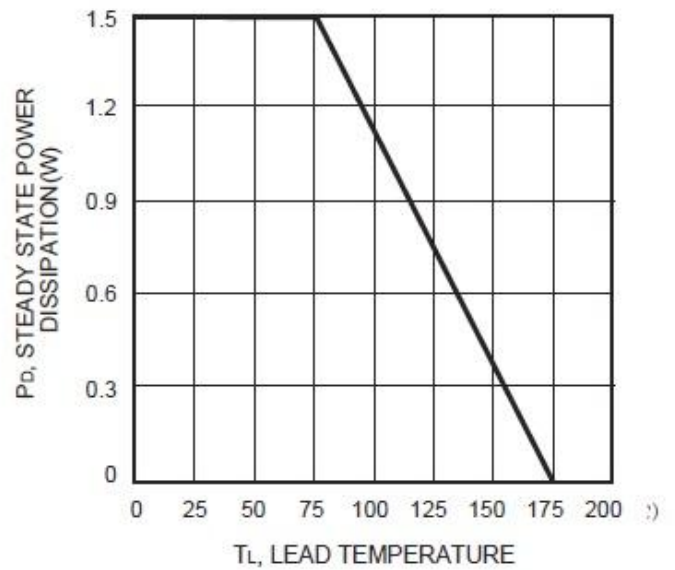
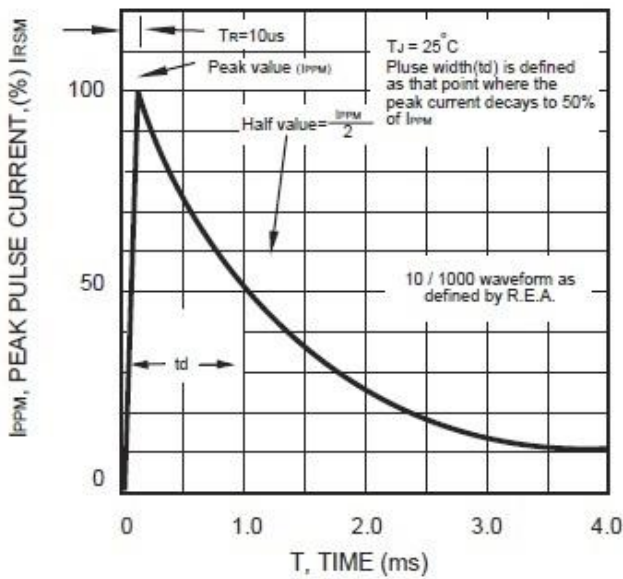

FIG.3 - PULSE WAVEFORM

FIG4: Power Derating Curve



Transient Voltage Suppression Diodes: P4KE Series

Axial Leaded Type 400 W



■ Soldering Recommendation

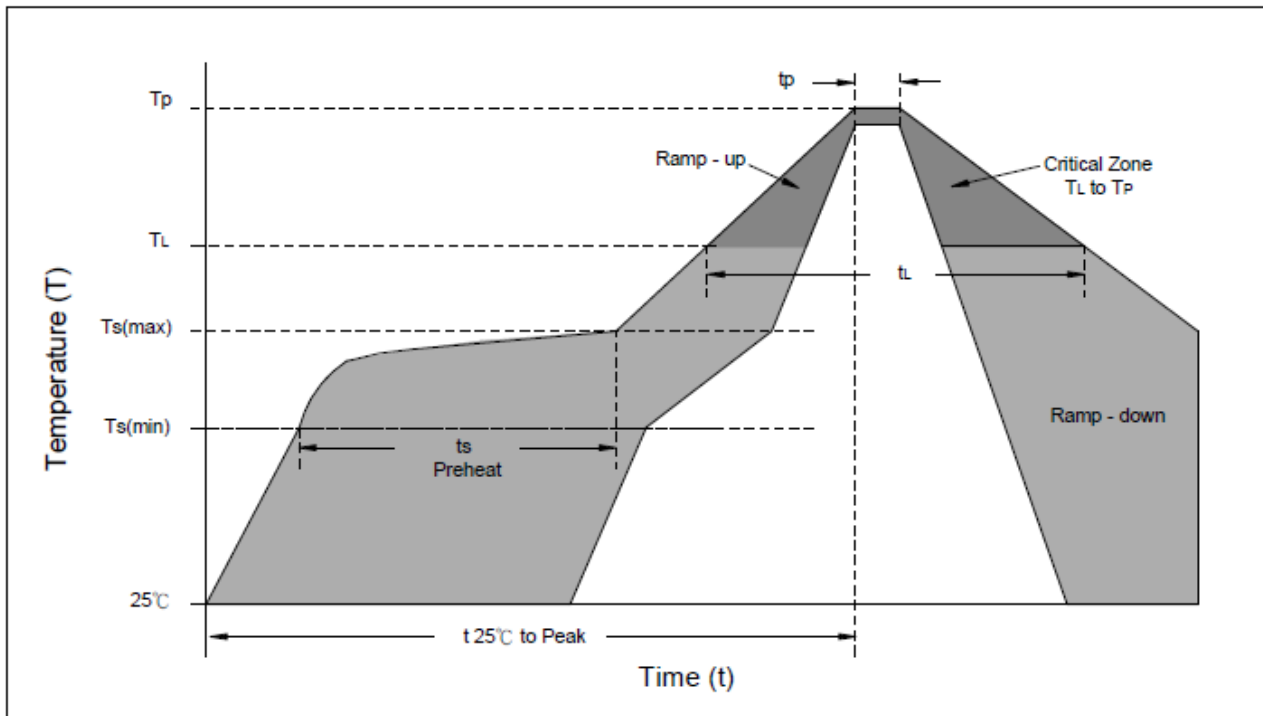

Reflow Condition	Lead-free assembly
Preheat -Temperature Min(Ts min) -Temperature Min(Ts max) -Time (min to max) (ts)	150°C 200°C 60 – 180 seconds
Average ramp up rate -Temperature Liquidus (TL) to peak	3°C/second max
Ts(max) to TL -Ramp-up Rate	3°C/second max.
Reflow -Temperature Liquidus (TL) -Time (tL)	217°C 60 – 150 seconds
Peak Temperature (TP)	260°C
Time within 5°C of actual peak Temperature(TP)	20 – 40 seconds
Ramp-down Rate	6°C/second max.
Time 25°C to peak Temperature(TP)	8 minutes max.
Do not exceed	260°C

Transient Voltage Suppression Diodes: P4KE Series

Axial Leaded Type 400 W



■ Quantity

Package Type	Reel Size inch	Reel Kpcs
DO-41	13	5

■ Warehouse Storage Conditions of product

- Storage condition:
 - 1.Storage Temperature: $-10^{\circ}\text{C} \sim +40^{\circ}\text{C}$
 - 2.Relative Humidity: $\leq 75\%RH$
 - 3.Keep away from corrosive atmosphere and sunlight.
- Period of Storage: 1 year.